

Temperature PID Controllers

H-D48 / H-D96W / H-D72 / H-D96H / H-D96Q Series



- * CE certification
- * Four groups of PID
- * Frequently uses the parameter may freely arrange to commonly used position
- * T/C, RTD. Linear input selectable
- * Auto/Manual control mode optional
- * Duplex Output Mode (Heat/Cool) through 2 control processes
- * Alarm Up to 3 alarm set
- * CT for heater break alarm
- * Programmable mode up to 8 ramp/soak segments
- * Operates on any line voltage from 90V AC to 260V AC at 50/60Hz
- * Optional RS-232 and RS-485 communication interface Modbus RTU available
- * Open loop motor valve control
- * Remote set-point
- * Soft start
- * Retransmission output

- CE 認證
- 多段PID記憶功能
- 參數可自行規劃
- 溫度訊號可由軟體直接選擇
- 手動/自動控制模式選擇
- (加熱/冷卻)雙輸出功能
- 三組警報
- 比流器，斷線警報
- 可程式功能
- 交換式電源設計
- RS-232/RS-485通訊功能
- 閥控制功能
- 遙控設定功能
- 緩啟動
- 再傳輸

Board Type PID Controllers

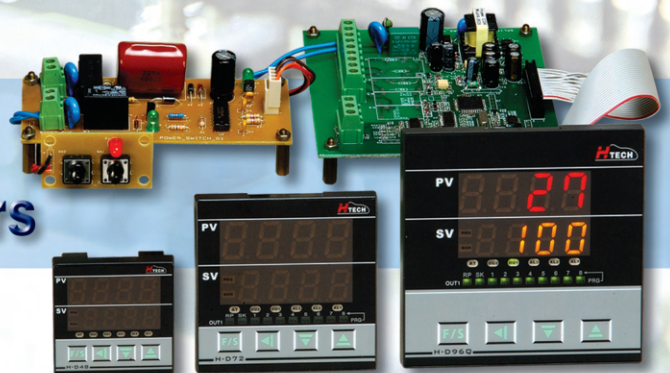

Dimension

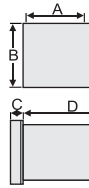

Panel cutout

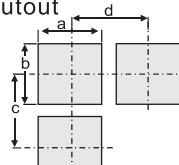

MODEL	A	B	C	D	E	a	b	c	d
H-D96Q	96	96	10.5	83	90	91 ^{+0.5} ₋₀	91 ^{+0.5} ₋₀	120	120
H-D72	72	72	10.5	83	67	68 ^{+0.5} ₋₀	68 ^{+0.5} ₋₀	100	100
H-D96W	96	48	10.5	83	43	91 ^{+0.5} ₋₀	46 ^{+0.5} ₋₀	70	120
H-D96H	48	96	10.5	83	90	46 ^{+0.5} ₋₀	91 ^{+0.5} ₋₀	120	70
H-D48	48	48	10.5	83	45	46 ^{+0.5} ₋₀	46 ^{+0.5} ₋₀	70	70

Available terminal

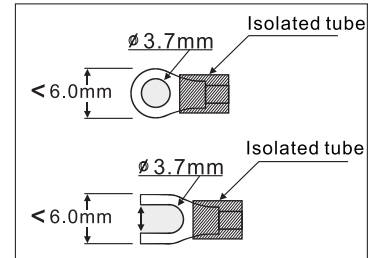

EXTERNAL TERMINAL

Host computer



RS-232

Communication level converter

RS-485



經銷商

H-D48

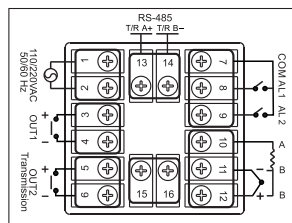

H-D72

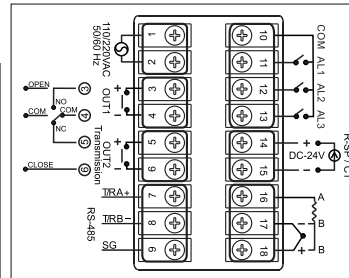

H-D96W, H-D96H, H-D96Q

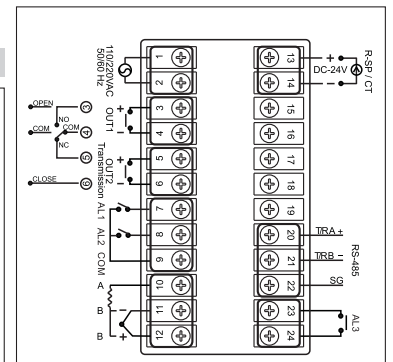

SPECIFICATIONS

Input Signal	Type of Input	TC (K,J,T,R,E,S,B,N) RTD (Pt100, JPt100) Linear(1-5V, 4-20mA)
	Input Sampling Time	300 ms
	Indication	PV/SV Indication Constant Value Storage System
Control Mode	Proportional Band (P)	0.0~3000
	Integral Time (I)	0~3600
	Derivative Time (D)	0~900
	Cycle Time	0~150
Control Output	Dead Band	0.0~200.0
	Relay Output Relay	Contact, SPST 3A/240V AC
	Voltage Output	Voltage Pulse
Alarm	Linear Output	4~20mA, 1-5V
	Motor Control Output	Open loop motor valve
Alarm	Channel	3 Channels (Optional)
Communication	Type of Communication	RS-232, RS-485 Modbus RTU protocol
General Specifications	Power Supply Voltage & Frequency	90~260V AC, 24V AC, 50/60Hz;24V DC
	Power Consumption	<3.5VA
	Ambient Temperature	-10°C ~55°C
	Ambient Humidity	0~80% RH

ORDERING INFORMATION

A TYPE	B INPUT	C OUTPUT 1	D OUTPUT 2	E ALARM	F ADDITION	G COMMUNICATION	H PROGRAM
D48 =48*48 D72 =72*72 D96Q =96*96 D96H =48*96 D96W =96*48	1=K 7=B 2=J 8=N 3=T 9=DIN/PT 4=R A=JIN/PT 5=E B=LINEAR 6=S	0=NONE 1=RELAY 2=PULSED 3=4-20M 4=1-5V 5=open loop motor valve	0=NONE 1=RELAY 2=PULSED 3=4-20M 4=1-5V 5=Transmission	0=NONE 1=ALARM*1 2=ALARM*2 3=ALARM*3	0=NONE 1=DC-24V 2=REMOTE-SP 3=CT	0=NONE 1=RS-485 2=RS-232	0=NONE 1=PROGRAM